

Tilt Stage Metric in Two Axes



Stock #55-459 **9 In Stock**

- 1 + £305^{.60}

ADD TO CART

Volume Pricing

Qty 1-9	£305.60 each
Qty 10+	£269.76 each
Need More?	Request Quote

! Prices shown are exclusive of VAT/local taxes

Product Downloads

General

Metric **Type:**

Physical & Mechanical Properties

Tip-Tilt **Type of Movement:**

60 x 60 **Stage Size (mm):**

±2.5 Travel (°):

M16 x 1 Center Hole:

Aluminium Stage Construction:

0.25 Leadscrew Pitch (mm):

3 Load Capacity (kg):

0.22 Weight (kg):

Hardware & Interface Connectivity

Fine Screw (100 Pitch) Type of Drive:

Threading & Mounting

(1) M16 x 1, (2) M6 x 1, (4) M4 x 0.7 Mounting Threads:

Regulatory Compliance

[Exempt](#) RoHS 2015:

[View](#) Certificate of Conformance:

[Contains SVHC\(s\)](#) Reach 247:

Product Details

- Tilt Control in Two Axes (±2.5°)
- Multiple Tapped and C'bored Holes for Easy Mounting
- Black Anodized Aluminum

Ideal for tilt control of both optics and mounting posts. Platform top plate has 4 M4 tapped holes at each corner (on 50mm centers) and one M16 tapped hole on center. Platform bottom plate has 2 counterbore holes for M4 SHCS, one M6 SHCS (on center) counterbore hole for mounting to our [Metric Breadboards and Base Plates](#), and one M6 tapped hole for mounting to our [Metric Stainless Steel Mounting Posts](#). Platform also features one M6 tapped hole for mounting vertically. Stage includes two M4 stainless steel socket head cap screws.

Compatible with the following stages: [#54-687](#), [#55-032](#), [#55-459](#), [#55-527](#), [#55-840](#), [#55-841](#), [#56-335](#), and [#56-336](#).

Technical Information

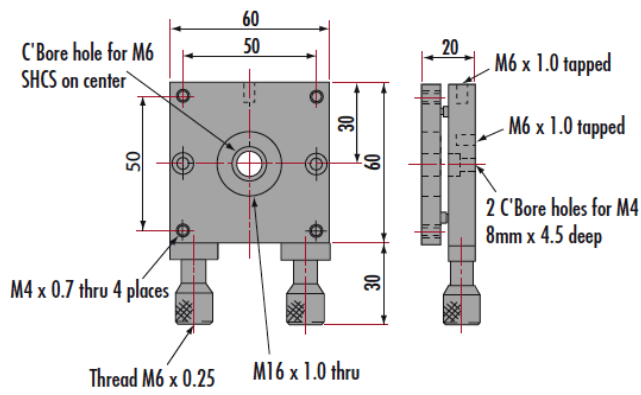

Units: mm