

[See all 49 Products in Family](#)

TECHSPEC® 8mm, f/5.6 UCi Series Fixed Focal Length Lens



8mm, f/1.8 UCi Series Fixed Focal Length Lens



Stock #28-637 **NEW** [CONTACT US](#)

− 1 + £188.⁰⁰

ADD TO CART

Volume Pricing

Qty 1+	£188.00 each
Need More?	Request Quote

! Prices shown are exclusive of VAT/local taxes

Product Downloads

General

UCi Series **Product Family:**

Fixed Focal Length Lens **Type:**

Fixed Focal Length Lens **Imaging Lens Type:**

Physical & Mechanical Properties

Fixed Iris Option:

49.75 Length (mm):

34 Maximum Diameter (mm):

34 Outer Diameter (mm):

25 Weight (g):

4.25 Maximum Rear Protrusion (mm):

44.50 Maximum Length (mm):

Optical Properties

44.7° Horizontal Field of View @ Max Sensor Format:

44.7° Horizontal Field of View, 1/2" Sensor:

40.7° Horizontal Field of View, 1/2.5" Sensor:

33.9° Horizontal Field of View, 1/3" Sensor:

25.6° Horizontal Field of View, 1/4" Sensor:

8.00 Maximum Image Circle (mm):

0.0098 Numerical Aperture NA, Object Side:

9 (8) Number of Elements (Groups):

8.00 Focal Length FL (mm):

50 - ∞ Working Distance (mm):

f/5.6 Aperture (f/#):

M4 MgF2 Coating:

M4 MgF2 Coating Specification:

22.07 Entrance Pupil Position (mm):

27.98 Object Space Principal Plane (mm):

1.77 Image Space Principal Plane (mm):

6.87 Maximum Distortion (%):

-20.88 Exit Pupil Position (mm):

VIS Lens Wavelength Range:

VIS Wavelength:

Sensor

1/2.5" Optimized Sensor Format:

1/2" Maximum Sensor Format:

1.85 Pixel Size (μm):

Threading & Mounting

M34 X0.05 Filter Thread:

N/a Filter Thread Adapter:

C-Mount Mount:

Environmental & Durability Factors

Storage Temperature (°C):

-20 to +60 For questions regarding operating temperature please contact our support team

Type of Ruggedization:

Industrial (Fixed Aperture with Simplified Mechanics)

Regulatory Compliance

Certificate of Conformance:

[View](#)

Product Details

- Up to 1/1.8", C-Mount, S-Mount Lens
- Up to 12 MegaPixels, 1.85µm Pixel Size Sensors
- Instrumentation (UCi) versions of our UC Series Lenses with Streamlined Mechanical Designs and Fixed Apertures
- 4mm to 35mm Focal Length

TECHSPEC® UCi Series Fixed Focal Length Lenses utilize the same optics as the TECHSPEC UC Series Lenses and feature 4K resolution. These lenses are designed for small pixels $\leq 2.2\mu\text{m}$ and offer a wide range of fixed apertures for a variety of applications. While optimized for 1/2.5" sensors, many focal length options can be used on sensors up to 1/1.8". TECHSPEC® UCi Series Fixed Focal Length Lenses are ideal for OEM applications that require small, robust, and lightweight imaging solutions.

Note: For adjustable aperture options, see our [TECHSPEC® UC Series Fixed Focal Length Lenses](#).

Edmund Optics has created a family of high-performance ultra-compact optical designs (the UC Series family) and developed 3 customized optomechanical solutions targeted for specific applications. These lens sub-families utilize the same optics as the UC Series lenses providing the same optical performance in a variety of optomechanical solutions to meet your application requirements:

UC Series: Features locking cam focus and iris adjustment in an ultra-compact design and is the most adjustable version of these optical designs; they are the typical high-quality machine vision lenses.

UCi Series: Simplified mechanics featuring fixed apertures with compact housing. [Industrial Ruggedization](#) for reduced size, cost, and locked focus.

UCr Series: All optics glued in place and a locking C-clamp focus ring. [Stabilized Ruggedization](#) for reduced pixel shift and improved focus stability.

UCw Series: Waterproof, designed to meet IEC [Ingress Protection](#) Code IPX7 to withstand exposure to water up to 1 meter depth for 30 minutes.

Technical Information

4mm Focal Length

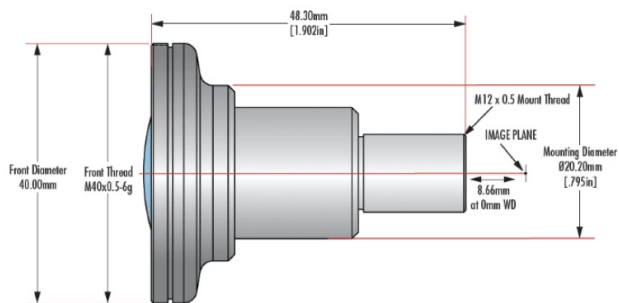

6mm Focal Length

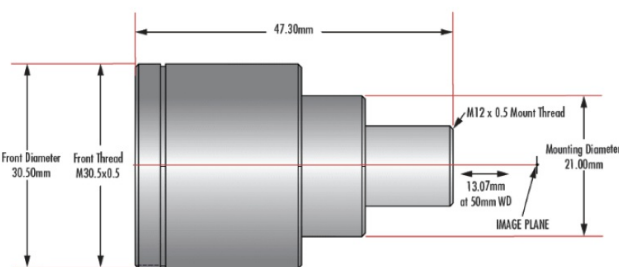

12mm Focal Length

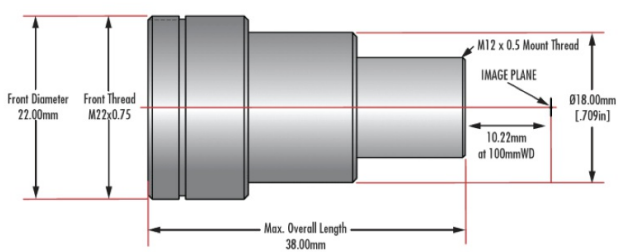

16mm Focal Length



25mm Focal Length



35mm Focal Length

