

6" Two-Arm Package, 4 Knuckles, (2) 6" Shafts



Stock #57-447 **3 In Stock**

- 1 + £96⁰⁰

ADD TO CART

Volume Pricing

Qty 1-9	£96.00 each
Qty 10+	£85.04 each
Need More?	Request Quote

! Prices shown are exclusive of VAT/local taxes

Product Downloads

General

English **Type:**

6" Two-Arm Package **Note:**

4 **Knuckles:**

(2) 6" **Shafts:**

Physical & Mechanical Properties

360
Coarse Rotation (°):

Construction:
6061-T6 Aluminum, Black Anodized Finish Shaft
6061-T6 Aluminum Natural Finish Pivot Ball
Zinc Die Cast, Natural Finish Locking Ring

Regulatory Compliance

Compliant
RoHS 2015:

View
Certificate of Conformance:

Product Details

- Mount and Set in Unique Orientations
- Mix and Match for Custom Mounting Combinations
- Lockable Angular Positioning

Articulating Arm Mounting Systems are designed to reach into areas not easily accessible with standard 1/4-20 mounting. These "arms" can be positioned in any angular setting (180°) via the ball-pivot assembly. A total 360° rotation can be achieved by tilting/turning the knuckle about the shaft. The position can be locked with the easily handled knob or the tamper-resistant set screw (Allen Key included). Articulating Arm Mounting Systems can be used for applications ranging from mounting optical assemblies to fixturing cameras. Individual components are available, as well as One-Arm and Two-Arm packages. The One-Arm package includes two knuckles and one shaft, and the Extended One-arm package includes three knuckles and two shafts for added reach and range. Our Two-Arm package includes four knuckles and two shafts for separate arm requirements, such as alignment of dual branch fiber optic light guides. Nylon washers are provided with knuckles to avoid scratching anodized surfaces. Additional [optical bench hardware set screws](#) (not included) are available.

Technical Information

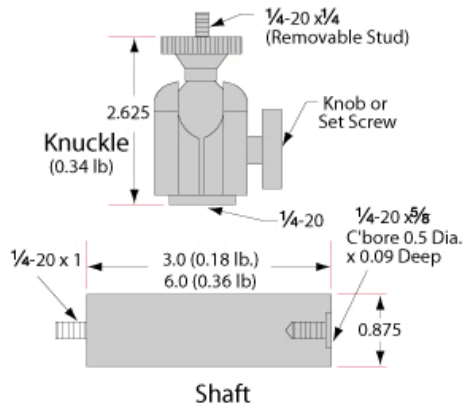

Units: Inches