

30° Travel, 40 x 40mm Stage Size Metric Goniometer, R62



Stock #55-839 **4 In Stock**

- 1 + £576.⁰⁰

ADD TO CART

Volume Pricing

Qty 1-4	£576.00 each
Qty 5+	£518.40 each
Need More?	Request Quote

! Prices shown are exclusive of VAT/local taxes

Product Downloads

General

Metric **Type:**

Physical & Mechanical Properties

Goniometer **Type of Movement:**

Dovetail **Guide System:**

40 x 40	Stage Size (mm):
±15	Travel (°):
Brass Stage	Construction:
3	Load Capacity (kg):
62	Radius R (mm):
0.2	Resolution (°):
0.2	Weight (kg):

Hardware & Interface Connectivity

Lead Screw	Type of Drive:
------------	-----------------------

Threading & Mounting

(1) M4 x 0.7, (4) M3 x 0.5, (4) M2 x 0.4	Mounting Threads:
--	--------------------------

Regulatory Compliance

Exempt	RoHS 2015:
View	Certificate of Conformance:
Contains SVHC(s)	Reach 247:

Product Details

- Stackable for Two-Axis Rotation
- Durable Brass Construction
- Dovetail Design with Vernier Scale

Metric Goniometers allow for precise angular adjustment of an object about a fixed point located above the center of the mounting surface. Stages with smaller radii can be mounted on top of larger radii stages of the same size to provide motion about a common point in two different axes. All stages feature a precision dovetail movement with a Vernier scale for high-resolution measurements and movement repeatability. Metric Goniometers feature a locking thumbscrew, allowing each stage to be held securely in place. Stage material is a durable black painted brass. An available 40mm square, 8mm thick top mounting adapter plate [#58-290](#) mounts to M3 holes and provides a counterbore for 1/4-20 or M6 socket head cap screw.

40mm Square Metric Goniometers are compatible with the following stages: [#55-029](#), [#55-030](#), [#55-031](#), [#55-838](#), and [#55-839](#).

60mm Square Metric Goniometers are compatible with the following stages: [#54-687](#), [#55-032](#), [#55-459](#), [#55-527](#), [#56-335](#), and [#56-336](#).

Technical Information

Stock No.	A	B	C	D
#13-629	15mm	20mm	31mm	7mm
#55-838	35mm	16mm	47mm	7mm
#55-839	51mm	15mm	62mm	6.5mm
#55-840	50mm	34mm	63mm	—
#55-841	84mm	31mm	95mm	—
#13-630	115mm	24mm	130.4mm	—

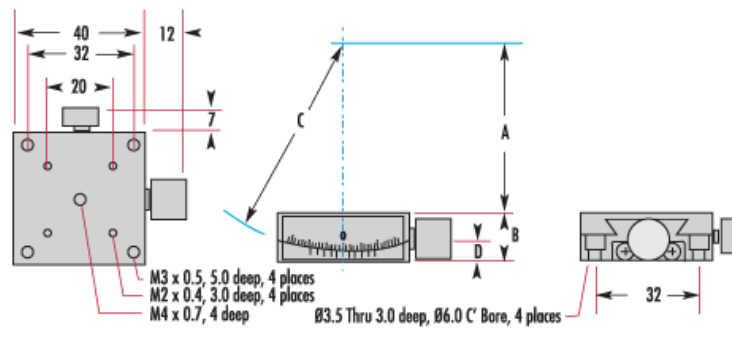

40mm Square



60mm Square