

[See all 18 Products in Family](#)

25.4mm Dia., 5 Arcsec, Bare Gold Replicated Hollow Metal Retroreflector

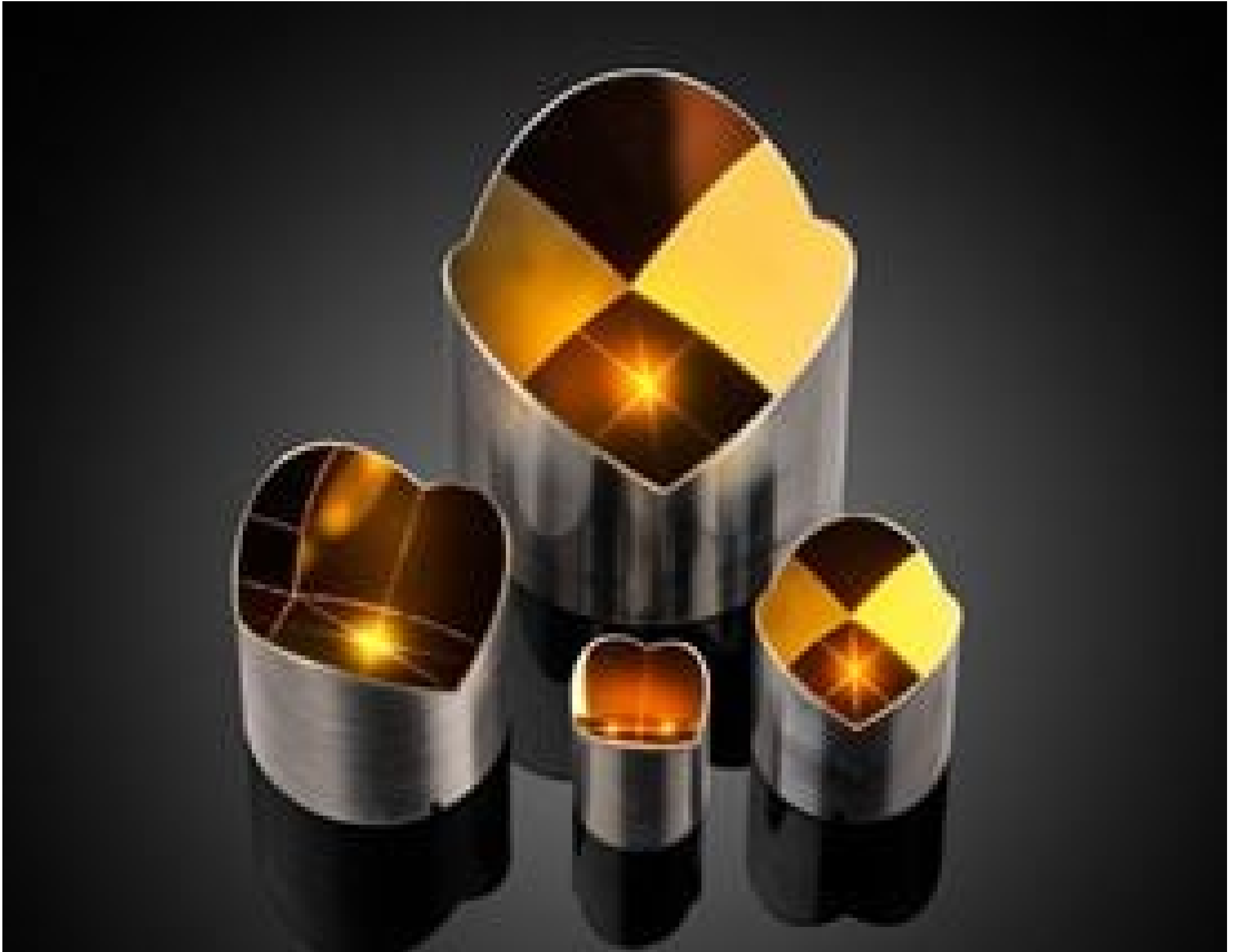

Replicated Hollow Metal Retroreflectors

Stock #15-901 **7 In Stock**

⊖ 1 ⊕ £520.⁰⁰

ADD TO CART

Volume Pricing	
Qty 1-9	£520.00 each
Qty 10-24	£483.60 each
Qty 25+	£442.00 each
Need More?	Request Quote

ⓘ Prices shown are exclusive of VAT/local taxes

Product Downloads

General

Retroreflector **Type:**

Standard Profile **Style:**

Physical & Mechanical Properties

Clear Aperture CA (mm):

22.86

Diameter (mm):

25.40

Height (mm):

30.66

Dimensional Tolerance (mm):

+0.025/-0.051

Optical Properties

Beam Deviation (arcsec):

5

Coating:

Bare Gold

Substrate:

Aluminum

Surface Quality:

60-40

Image Orientation:

Left-Handed

Coating Specification:

R_{avg} >94% @ 700 - 800nm
R_{avg} >97% @ 800 - 2000nm
R_{avg} >98% @ 2 - 12μm

Ray Deviation (°):

180

Wavelength Range (nm):

700 - 12000

Threading & Mounting

Mounting Threads:

10-24

Regulatory Compliance

Certificate of Conformance:

[View](#)

Product Details

- Monolithic Aluminum Construction
- Return Beam Accuracy Unaffected by Vibration
- Bare Gold or Enhanced Aluminum Coating Options
- Low Profile Versions are Available

Replicated Hollow Metal Retroreflectors feature a monolithic aluminum construction and an integrated mount to provide return beam performance unaffected by vibration. These retroreflectors are offered with bare gold coatings applied to the first surface, maximizing their reflectivity in the infrared (IR), or enhanced aluminum coatings for optimal performance in the visible spectrum. Designed to have the entirety of their optical path in air, these retroreflectors do not require antireflection coatings for optimal performance and can be used over wider wavelength ranges than glass retroreflectors. Replicated Hollow Metal Retroreflectors are ideal for applications where an optical path through a glass prism is undesired, reduced weight is required, or where high shock and vibration levels are expected. The replication manufacturing process of these optics enables cost-effective designs while providing high performance beam return accuracy.

Technical Information

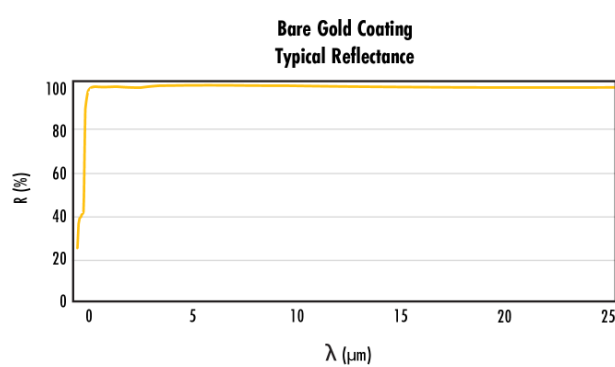
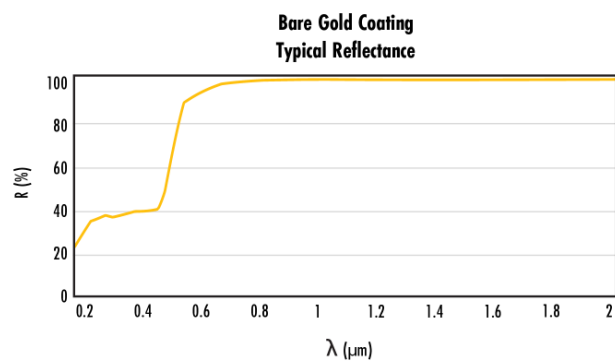

REPLICATED HOLLOW METAL RETROREFLECTORS

Diameter (mm)	Height (mm)	Mounting Threads	Coating	Stock No.	
				5 Arcseconds	10 Arcseconds
12.7	21.68	10-24	Bare Gold	#15-897	#15-898
19.1	26.17	10-24	Bare Gold	#15-899	#15-900
25.4	30.66	10-24	Bare Gold	#15-901	#15-902
38.1	39.64	10-24	Bare Gold	#15-903	#15-904

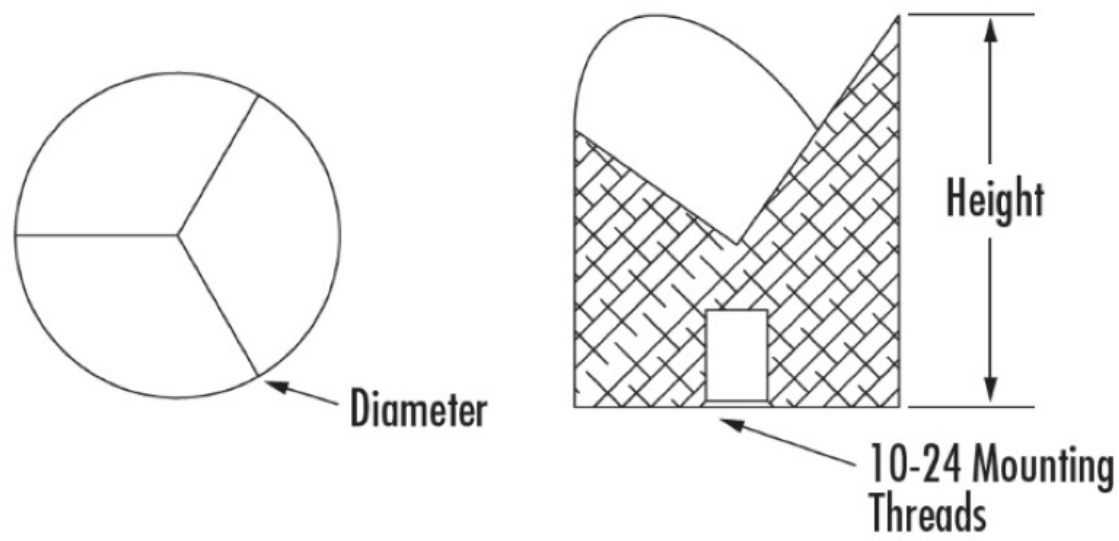

LOW PROFILE REPLICATED HOLLOW METAL RETROREFLECTORS

Dimension A (mm)	Dimension B (mm)	Dimension C (mm)	Coating	Stock No.		
				2 Arcseconds	5 Arcseconds	10 Arcseconds
12.7	8.63	12.8	Bare Gold	N/A	#23-854	#23-855
25.4	20.32	21.77	Bare Gold	#23-856	#23-857	#23-858

