

**TECHSPEC® 16mm, f/16 Ci Series Fixed Focal Length Lens**



16mm Focal Length

Stock #85-336 **20+ In Stock**

⊖ 1 ⊕ £170.<sup>00</sup>

**ADD TO CART**

Volume Pricing	
Qty 1-24	£170.00 each
Qty 25+	£153.00 each
Need More?	<a href="#">Request Quote</a>

ⓘ Prices shown are exclusive of VAT/local taxes

Product Downloads

**General**

Ci Series **Product Family:**  
Fixed Focal Length Lens **Type:**

**Physical & Mechanical Properties**

Fixed **Iris Option:**

40.80	Length (mm):
26.5	Maximum Diameter (mm):
26.5	Outer Diameter (mm):
37	Weight (g):
1.09	Maximum Rear Protrusion (mm):
26.50	Diameter (mm):

## Optical Properties

61.4mm - 30.9°	Horizontal Field of View @ Max Sensor Format:
Horizontal: 59.7mm - 30.9° Vertical: 44.6mm - 23.4° Diagonal: 75mm - 38.2°	Field of View at Max Sensor Format:
61.4mm - 30.9°	Horizontal Field of View, 2/3" Sensor:
50.1mm - 25.2°	Horizontal Field of View, 1/1.8" Sensor:
44.5mm - 22.7°	Horizontal Field of View, 1/2" Sensor:
39.6mm - 20.2°	Horizontal Field of View, 1/2.5" Sensor:
33.3mm - 17.1°	Horizontal Field of View, 1/3" Sensor:
25mm - 12.8°	Horizontal Field of View, 1/4" Sensor:
11.00	Maximum Image Circle (mm):
0.0041	Numerical Aperture NA, Object Side:
7 (6)	Number of Elements (Groups):
16.00	Focal Length FL (mm):
100 - ∞	Working Distance (mm):
f/16	Aperture (f#):
425 - 675nm BBAR	Coating:
425 - 675nm BBAR	Coating Specification:
19.19	Entrance Pupil Position (mm):
21.30	Object Space Principal Plane (mm):
-3.00	Image Space Principal Plane (mm):
-0.77	Maximum Distortion (%):
-5.43	Exit Pupil Position (mm):
VS	Lens Wavelength Range:

## Sensor

2/3"	Maximum Sensor Format:
2.74	Pixel Size (μm):

## Threading & Mounting

M25.5 x 0.50 (Male)	Filter Thread:
<a href="#">#89-941 (Required)</a>	Filter Thread Adapter:
M22.0 x 0.75 (Male)	Front Thread:

C-Mount

Mount:

## Environmental & Durability Factors

**-20 to +60**

Storage Temperature (°C):

**Type of Ruggedization:**  
Industrial (Fixed Aperture with Simplified Mechanics)

## Regulatory Compliance

**Compliant** **RoHS 2015:**

**View** **Certificate of Conformance:**

**Compliant** **Reach 235:**

## Product Details

These compact lenses are designed specifically for volume integration into applications such as analytical medical devices, including benchtop-based blood analyzers. For customized *f/#* versions to best suit your instrumentation application needs and to discuss volume requirements, please [contact us](#).

- Up to 2/3", C-Mount Lens
- Up to 7.5 MegaPixels, 2.8µm Pixel Size Sensors
- Instrumentation (Ci) Versions of our C Series Lenses with Streamlined Mechanical Designs and Fixed Apertures
- 3.5mm to 50mm Focal Length
- **Ruggedized (Cr) Designs** Also Available

TECHSPEC® Ci Series Fixed Focal Length Lenses are a streamlined version of our C Series Fixed Focal Length Lenses. They feature the same low lens-to-lens variation and broadband anti-reflection (BBAR) coating for maximum light transmission, while offering reduced weight and size. An adjustable, lockable focus allows for setting and locking the best focus position for instrumentation integration. TECHSPEC® Ci Series Fixed Focal Length Lenses are designed specifically for volume integration into applications such as factory inspection and automation to benchtop biomedical devices. The Ci Series offers a wide range of aperture options, ensuring maximum flexibility of resolution, throughput, and depth of field.

Edmund Optics has created a family of high performance optical designs (the C Series family) and developed 6 customized optomechanical solutions targeted for specific applications. These lens sub-families utilize the same optics as the C Series lenses providing the same optical performance in a variety of optomechanical solutions to meet your application requirements:

- **C Series:** Features locking cam focus and iris adjustment and is the most adjustable version of these optical designs; they are the typical high quality machine vision lenses. Also available with a **VIS-NIR Broadband Anti-Reflection (BBAR) Coating**.
- **Ci Series:** Simplified mechanics featuring fixed apertures with compact housing. **Industrial Ruggedization** for reduced size, cost, and locked focus.
- **Cr Series:** All optics glued in place and a locking C-clamp focus ring. **Stabilized Ruggedization** for reduced pixel shift and improved focus stability.
- **Cx Series:** Modular, flexible mechanics allows lenses to be taken apart for easy integration of accessories such as liquid lenses, apertures, and more.
- **Liquid Lens Cx Series:** Designed with an integrated liquid lens for quick autofocus.
- **Cw Series:** Waterproof, designed to meet IEC **Ingress Protection** Code IPX7 and IPX9K.

## Technical Information

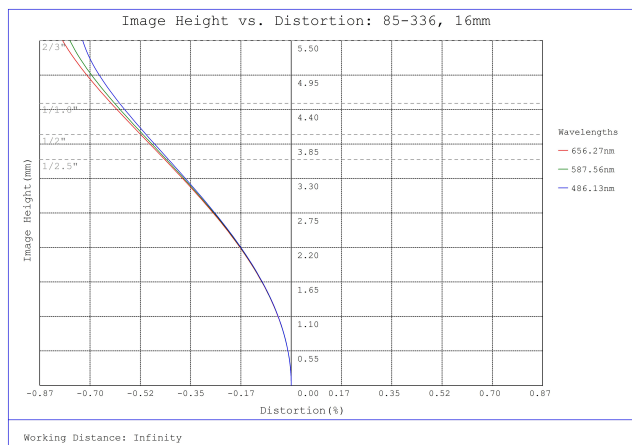

#85-336, 16mm, f/16 Ci Series Fixed Focal Length Lens, Distortion Plot

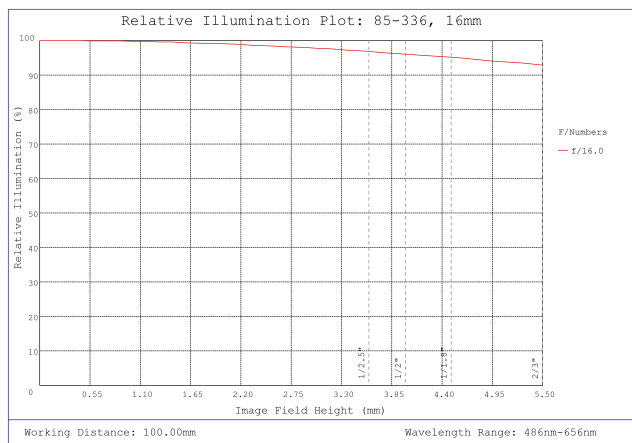

#85-336, 16mm, f/16 Ci Series Fixed Focal Length Lens, Relative Illumination Plot

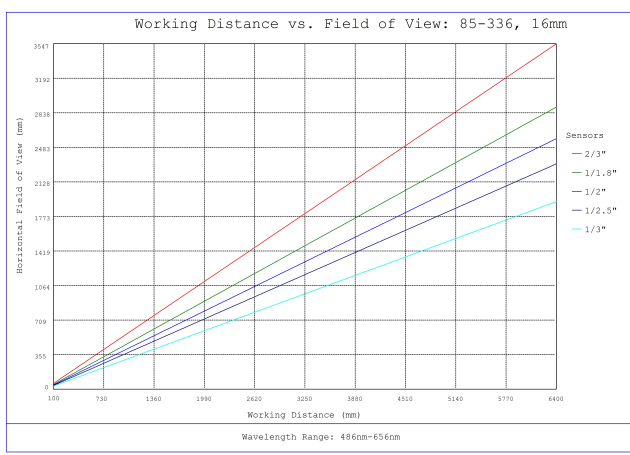

#85-336, 16mm, f/16 Ci Series Fixed Focal Length Lens, Working Distance versus Field of View Plot

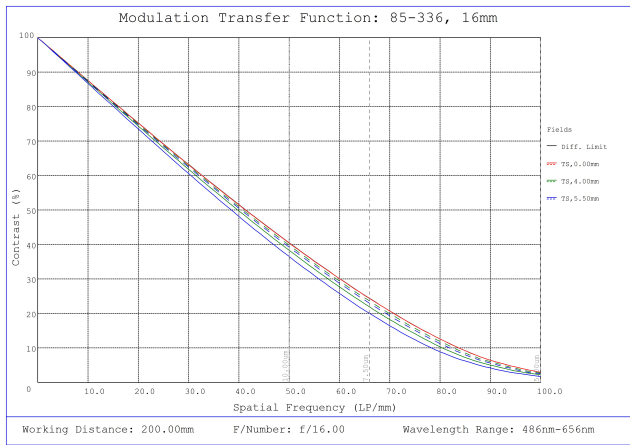

#85-336, 16mm, f/16 Ci Series Fixed Focal Length Lens, Modulated Transfer Function (MTF) Plot, 200mm Working Distance, f16

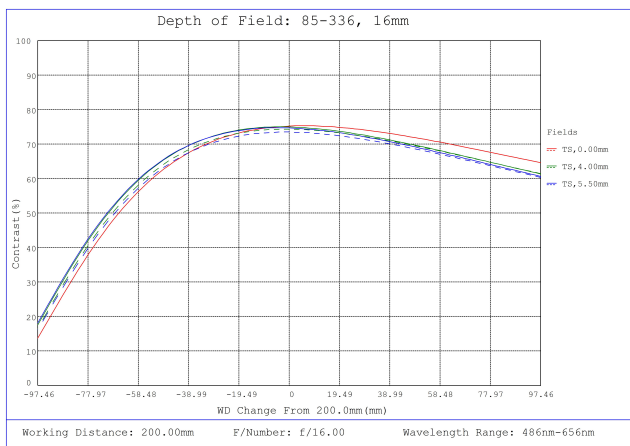

#85-336, 16mm, f/16 Ci Series Fixed Focal Length Lens, Depth of Field Plot, 200mm Working Distance, f16

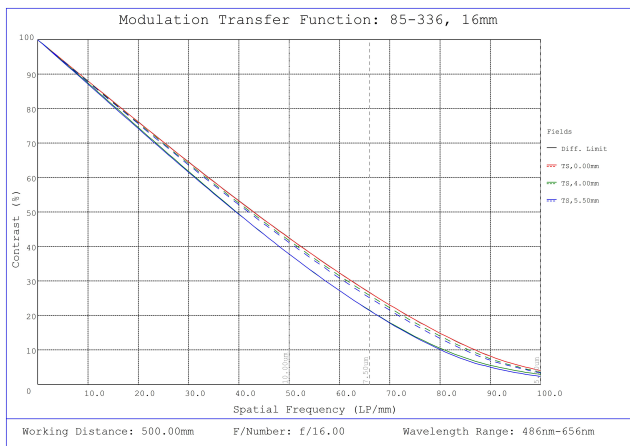

#85-336, 16mm, f/16 Ci Series Fixed Focal Length Lens, Modulated Transfer Function (MTF) Plot, 500mm Working Distance, f16

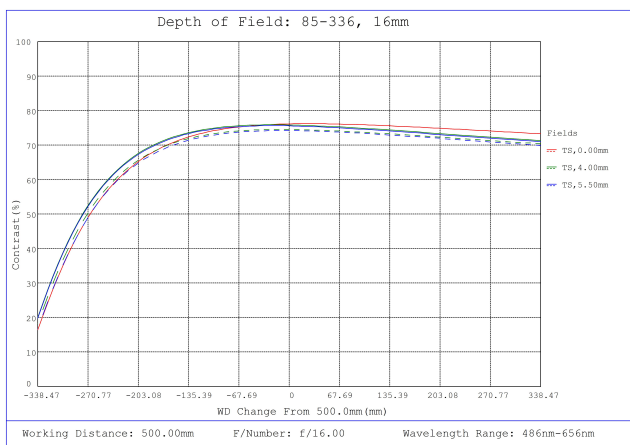

#85-336, 16mm, f/16 Ci Series Fixed Focal Length Lens, Depth of Field Plot, 500mm Working Distance, f16

Focal Length	A	B	C	D
6mm	M34.0 x 0.5	47.8mm	34mm	1.17mm
12mm	M22.0 x 0.75	29.0mm	22mm	0.96mm
16mm	M22.0 x 0.75	40.8mm	22mm	1.09mm
25mm	M22.0 x 0.75	29.9mm	22mm	1.33mm
35mm	M25.5 x 0.5	41mm	22.5mm	3.82mm
50mm	M30.5 x 0.5	49.5mm	30.5mm	2.06mm

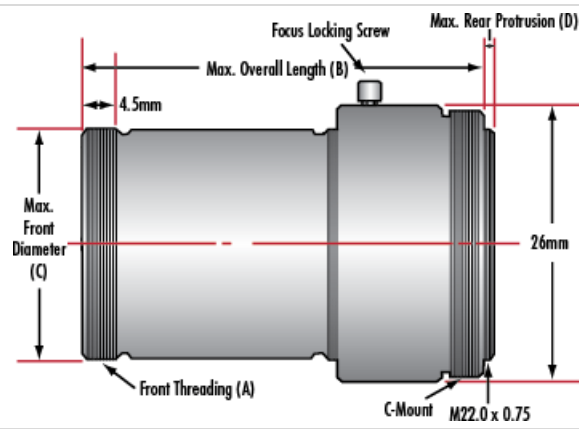

## Compatible Cameras