

TECHSPEC® 15X Arcturus® HeNe Beam Expander



15X HeNe Fixed Beam Expander, #58-209

Stock #58-209 **13 In Stock**

⊖ 1 ⊕ £504⁰⁰

ADD TO CART

Volume Pricing	
Qty 1-4	£504.00 each
Qty 5-24	£448.00 each
Qty 25-99	£399.20 each
Need More?	Request Quote

ⓘ Prices shown are exclusive of VAT/local taxes

Product Downloads

General

Beam Expander **Type:**
Fixed Magnification **Style:**

Physical & Mechanical Properties

Length (mm):

120.50

Weight (g):

461

Housing Diameter (mm):

50

Optical Properties

Entrance Aperture (mm):

2

Exit Aperture (mm):

27

Expansion Power:

15X

Focus Range (mm):

1.2m - ∞

Substrate: □

Optical Glass

Angle of Incidence (°):

0

Coating:

BBAR (450-750nm)

Design Wavelength DWL (nm):

633

Transmitted Wavefront, P-V:

<λ/4 @ 633nm for Input Beam ≤1mm

Wavelength Range (nm):

450 - 750

Coating Specification:

R_{abs} <0.4% @ 630 - 670nm
R_{avg} <0.6% @ 450 - 750nm

Divergence Adjustment:

Non-Rotating Optics

Threading & Mounting

Mounting Threads:

C-Mount

Regulatory Compliance

RoHS 2015:

Compliant

Certificate of Conformance:

[View](#)

Product Details

- AR Coated for HeNe Laser Wavelength of 633nm
- Fixed Magnifications Available from 3X to 20X
- Divergence Adjustable with Non-Rotating Optics

TECHSPEC® Arcturus® HeNe Beam Expanders offer high performance optical designs packaged in a precise opto-mechanical platform. Two full rotations of the adjustment knurl provide smooth movement for the optics in order to vary the output from collimated to the minimum focus distance of 1.2 meters. The precise adjustment mechanism keeps optics from rotating, which helps maintain bore sight accuracy and a minimally aberrated beam. Adjustment lock secures position. TECHSPEC® Arcturus® HeNe Beam Expanders are easily secured to both metric and English threaded mounts. Four tapped holes (two M6 on 25mm centers and two 1/4-20 on 1" centers) are located near the middle of the assembly for mounting.

For more cost sensitive applications, Edmund Optics also offers [TECHSPEC Scorpii® Nd:YAG Beam Expanders](#). For applications where rotating optics are acceptable, the [TECHSPEC Vega® Laser Line Beam Expanders](#) and [TECHSPEC Vega® Broadband Beam Expanders](#) are available. For higher precision applications where sliding optics are necessary, please see our [TECHSPEC Draconis® Nd:YAG Laser Line Beam Expanders](#) or [TECHSPEC Draconis® Broadband Beam Expanders](#). For broadband or ultrafast applications, [TECHSPEC Canopus® Reflective Beam Expanders](#) are available.



Technical Information

Complete Beam Expander

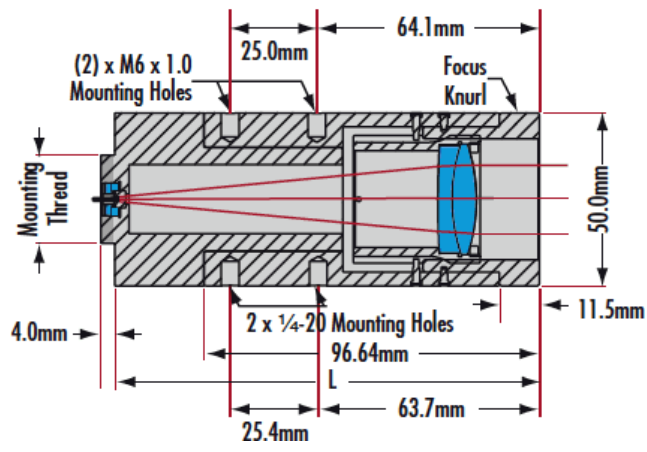

Beam Expander Mounting Configurations.

Click on an item below to be brought to that item's product page.

