

[See all 34 Products in Family](#)

TECHSPEC® 1:3.3 with 30mm and 100mm EFL Achromats, 30mm Achromatic Pair



TECHSPEC Mounted Achromatic Lens Pairs

Stock **#46-006** [CONTACT US](#)

⊖ 1 ⊕ £211²⁰

ADD TO CART

Volume Pricing

Qty 1-5	£211.20 each
Qty 6-25	£168.80 each
Qty 26-49	£164.00 each
Need More?	Request Quote

! Prices shown are exclusive of VAT/local taxes

Product Downloads

General

Relay Lens **Type:**

Physical & Mechanical Properties

22.0 **Clear Aperture CA (mm):**

Center Air Spacing (mm):

3.09

Housing Diameter (mm):
30 +0.0/-0.10

Housing Length (mm):
34 ±0.2

Lens Edge Spacing at Mount (mm):
8

Image Distance (mm):
90.13

Construction:
Achromat Pair in Anodized Aluminum Housing

Optical Properties

Substrate:
[N-BAF10](#) / [N-SF10](#) / [N-BK7](#) / [N-SF5](#)

Surface Quality:
40-20

Working f#:
f/4.09

Coating:
MgF₂ (400-700nm)

Coating Specification:
R_{avg} ≤ 1.75% @ 400 - 700nm

Effective Focal Length EFL A (mm):
30.00

Effective Focal Length EFL B (mm):
100.00

Magnification:
1:3.33

Object Distance (mm):
19.19

Wavelength Range (nm):
400 - 700

Regulatory Compliance

RoHS 2015:
[Compliant](#)

Reach 209:
[Compliant](#)

Certificate of Conformance:
[View](#)

Product Details

- 15mm and 30mm Diameter Options
- AR Coated Lenses
- Mounted Achromatic Pairs Kits Available

TECHSPEC® Mounted Achromatic Lens Pairs combine popular TECHSPEC® Achromats into common configurations used for relay and projection applications. Packaged in slim-line aluminum housing, each pair is ready for integration into a host of OEM applications, eliminating the need to handle loose optics. 15.0mm pairs can be coupled into C-mount components using [Helicoid Barrel Accessory](#). TECHSPEC Mounted Achromatic Lens Pairs have also been oriented for optimum system performance. All lenses, 15.0mm and 30.0mm, are AR coated. Lower f# pairs may not be ideal for imaging applications depending on the performance requirements. Cylinder lenses can be incorporated into empty barrels in order to generate lines or sheets of light.

Technical Information

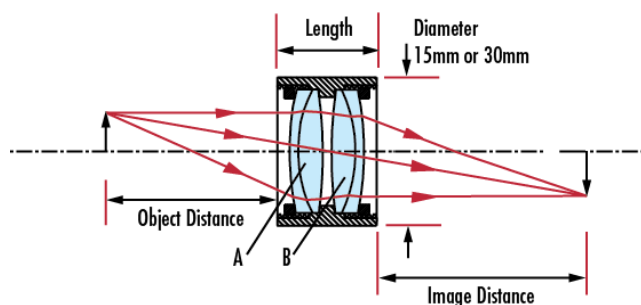

Coating Curves