

[See all 243 Products in Family](#)

TECHSPEC® 12.7mm Dia. x 30.0mm FL, Uncoated, Plano-Convex Lens



Stock **#37-802** **20+ In Stock**

[Other Coating Options](#)

⊖ 1 ⊕ £25⁴⁰

ADD TO CART

Volume Pricing	
Qty 1-9	£25.40 each
Qty 10-24	£23.00 each
Qty 25-49	£20.20 each
Need More?	Request Quote

ⓘ Prices shown are exclusive of VAT/local taxes

Product Downloads

General

Plano-Convex Lens **Type:**

Physical & Mechanical Properties

12.70 +0.0/-0.025	Diameter (mm):
<1	Centering (arcmin):
2.70 ±0.10	Center Thickness CT (mm):
1.34	Edge Thickness ET (mm):
12	Clear Aperture CA (mm):
Protective as needed	Bevel:

Optical Properties

30.00 @ 587.6nm	Effective Focal Length EFL (mm):
28.22	Back Focal Length BFL (mm):
Uncoated	Coating:
N-BK7	Substrate: <input type="checkbox"/>
40-20	Surface Quality:
1.5λ	Power (P-V) @ 632.8nm:
λ/4	Irregularity (P-V) @ 632.8nm:
±1	Focal Length Tolerance (%):
15.51	Radius R₁ (mm):
2.36	f#:
0.21	Numerical Aperture NA:
350 - 2200	Wavelength Range (nm):

Regulatory Compliance

View	Certificate of Conformance:
Compliant	Reach 240:

Need different specs or modifications?

Edmund Optics offers comprehensive custom manufacturing services for optical and imaging components tailored to your specific application requirements. Whether in the prototyping phase or preparing for full-scale production, we provide flexible solutions to meet your needs. Our experienced engineers are here to assist—from concept to completion.

Our capabilities include:

- Custom dimensions, materials, coatings, and more
- High-precision surface quality and flatness
- Tight tolerances and complex geometries
- Scalable production—from prototype to volume

Learn more about our [custom manufacturing capabilities](#) or submit an inquiry [here](#).

Product Details

- Wavelength Range of 350-2200nm
- Precision Diameter and Centration Tolerances Allow for Easy OEM Integration
- Wide Variety of Diameters, Focal Lengths, and Coatings
- Anti-Reflection PCX Coating Options: [MgF₂](#), [VIS 0°](#), [VIS-NIR](#), [NIR I](#), [NIR II](#), [VIS-EXT](#), and [YAG-BBAR](#)

TECHSPEC® Uncoated Plano-Convex (PCX) Lenses have a positive focal length, making them ideal for collecting and focusing light in imaging applications. These lenses excel in optical systems by concentrating light onto a detector or imaging plane, enhancing clarity and detail. They are also valuable for a variety of applications involving emitters, detectors, lasers, and fiber optics.

Plano-Convex lenses are ideal for a multitude of optics and photonics applications, including biotech instruments such as DNA sequencers and polymerase chain reaction (PCR) testing platforms. Their uncoated design ensures consistent performance across a broad wavelength range, making them versatile and reliable components for various optical setups.

TECHSPEC Uncoated Plano-Convex (PCX) Lenses are available in a wide variety of diameters and focal lengths. Identical designs of these PCX lenses are also offered with broadband anti-reflective (BBAR) coatings, which include [MgF₂](#), [VIS 0°](#), [VIS-NIR](#), [NIR I](#), [NIR II](#), [VIS-EXT](#), and [YAG-BBAR](#).

These coatings minimize surface reflections and maximize light transmission across different spectral ranges, ensuring optimal performance in various imaging and photonics applications. Whether for general use or specialized needs, TECHSPEC® PCX Lenses deliver precision and adaptability to enhance the effectiveness of optical systems.

Customers can utilize TECHSPEC® Uncoated Plano-Convex (PCX) Lenses in various ways:

- For emitters and detectors, these lenses are ideal for focusing and collimating light to enhance signal detection.
- In laser applications, they can be used to focus laser beams or to couple light efficiently into optical fibers, improving the performance of laser systems.
- For fiber optics, PCX lenses help couple light between fibers and other optical components, optimizing signal transmission and minimizing loss.
- In biotech instruments such as DNA sequencers and PCR testing platforms, these lenses focus light onto samples or detectors. Their ability to provide precise light collection and focusing enhances the accuracy and reliability of optical measurements, making them essential for high-resolution imaging and detection tasks.

By integrating TECHSPEC® Uncoated PCXLenses into these systems, customers can achieve improved optical performance and enhanced functionality across various photonics and optical applications.

TECHSPEC Uncoated Plano-Convex (PCX) Lenses are available in a variety of diameters, focal lengths, and optical materials. Plano-convex lenses are manufactured from high quality materials such as UV Grade Fused Silica, N-BK7 Optical Glass, and a wide variety of [Infrared \(IR\) materials](#). Different materials are useful for a variety of applications; review our [lens material selection tech note](#) for additional information.

Technical Information

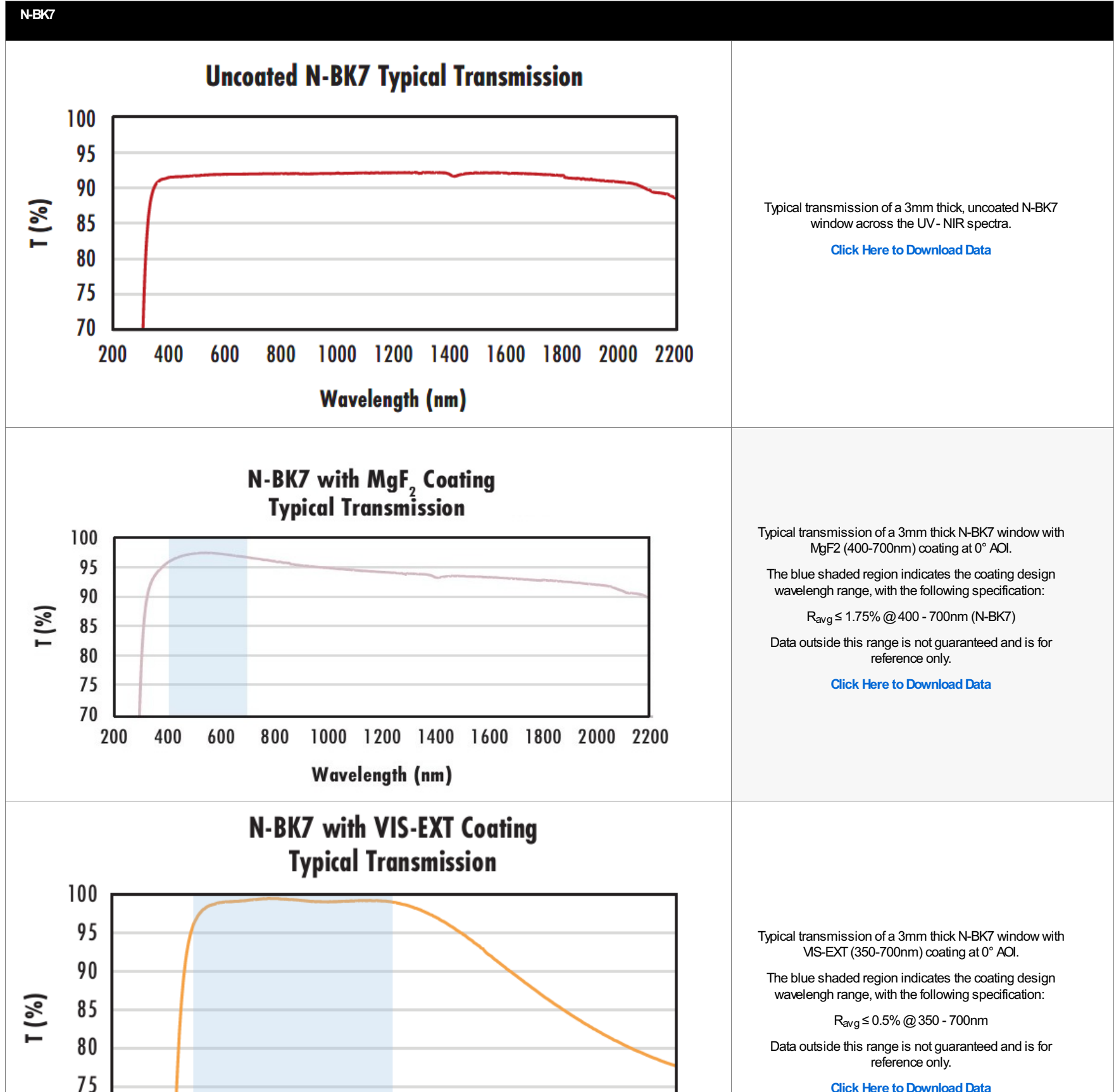
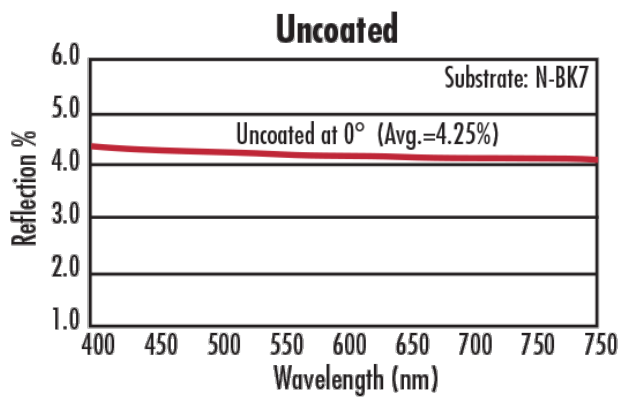
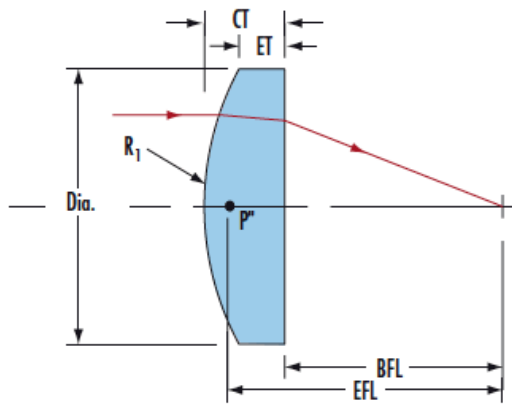

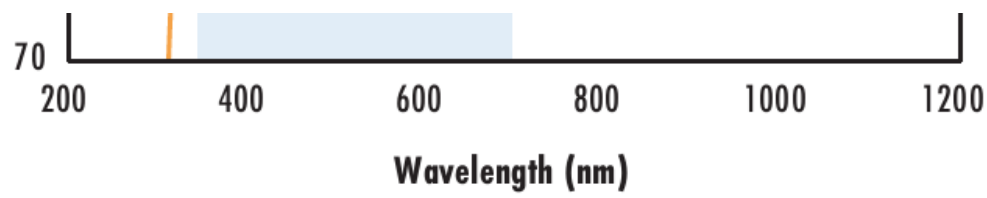

**N-BK7 with VIS-NIR Coating
Typical Transmission**

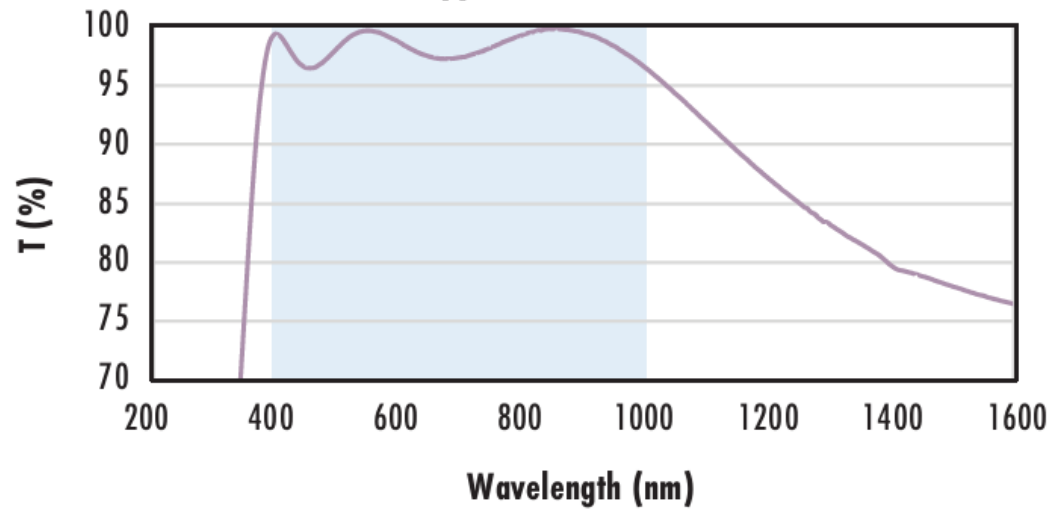

Typical transmission of a 3mm thick N-BK7 window with VIS-NIR (400-1000nm) coating at 0° AOI.

The blue shaded region indicates the coating design wavelength range, with the following specification:

$$R_{abs} \leq 0.25\% @ 880\text{nm}$$

$$R_{avg} \leq 1.25\% @ 400 - 870\text{nm}$$

$$R_{avg} \leq 1.25\% @ 890 - 1000\text{nm}$$

Data outside this range is not guaranteed and is for reference only.

[Click Here to Download Data](#)

**N-BK7 with VIS 0° Coating
Typical Transmission**

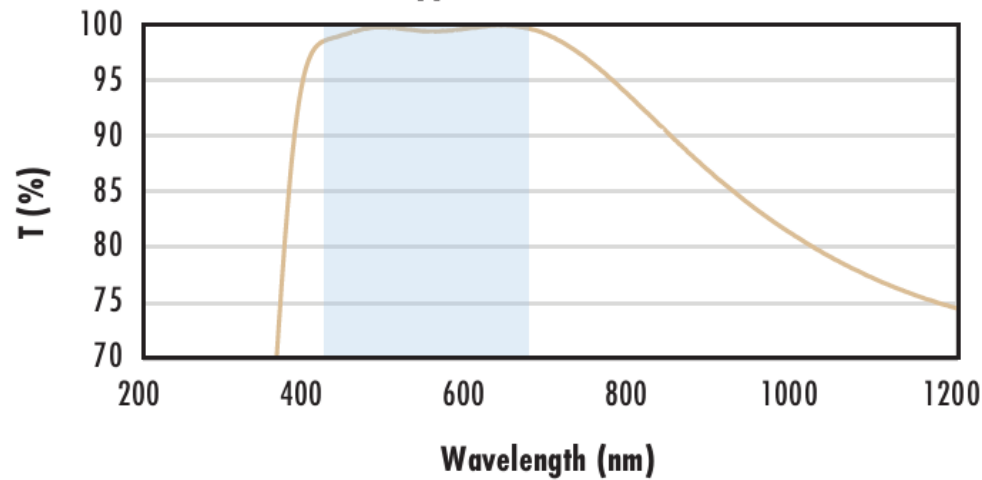

Typical transmission of a 3mm thick N-BK7 window with VIS 0° (425-675nm) coating at 0° AOI.

The blue shaded region indicates the coating design wavelength range, with the following specification:

$$R_{avg} \leq 0.4\% @ 425 - 675\text{nm}$$

Data outside this range is not guaranteed and is for reference only.

[Click Here to Download Data](#)

**N-BK7 with YAG-BBAR Coating
Typical Transmission**

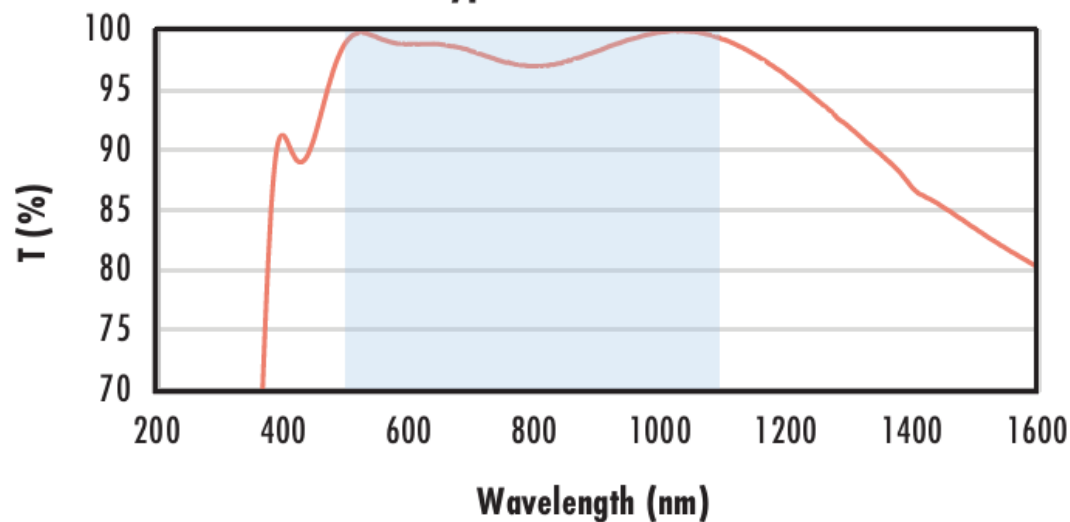

Typical transmission of a 3mm thick N-BK7 window with YAG-BBAR (500-1100nm) coating at 0° AOI.

The blue shaded region indicates the coating design wavelength range, with the following specification:

$$R_{abs} \leq 0.25\% @ 532\text{nm}$$

$$R_{abs} \leq 0.25\% @ 1064\text{nm}$$

$$R_{avg} \leq 1.0\% @ 500 - 1100\text{nm}$$

Data outside this range is not guaranteed and is for reference only.

[Click Here to Download Data](#)

**N-BK7 with NIR I Coating
Typical Transmission**



Typical transmission of a 3mm thick N-BK7 window with NIR I (600 - 1050nm) coating at 0° AOI.

The blue shaded region indicates the coating design wavelength range, with the following specification:

$$R_{avg} \leq 0.5\% @ 600 - 1050\text{nm}$$

Data outside this range is not guaranteed and is for reference only.

[Click Here to Download Data](#)

**N-BK7 with NIR II Coating
Typical Transmission**

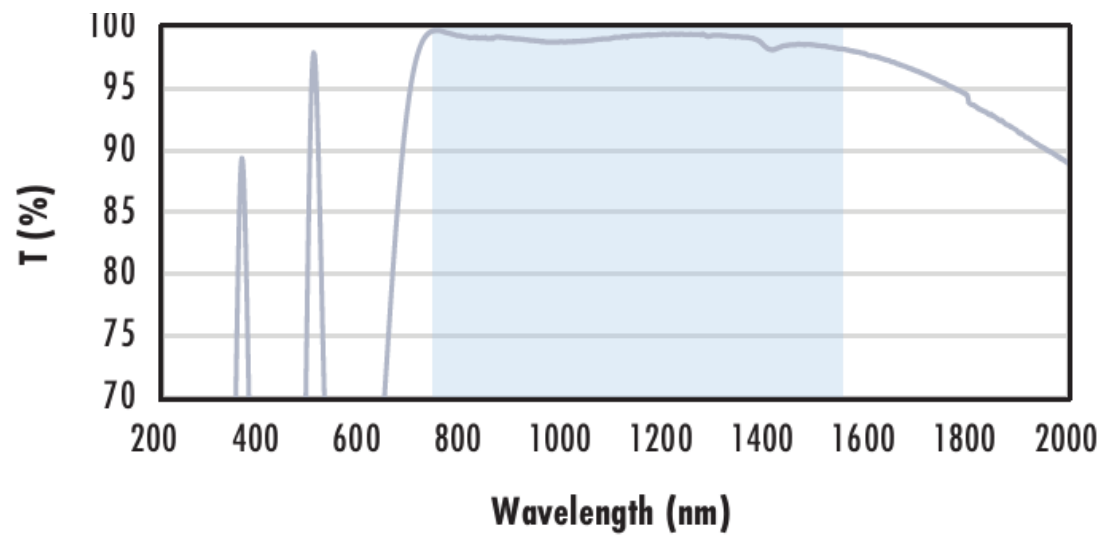

Typical transmission of a 3mm thick N-BK7 window with NIR II (750 - 1550nm) coating at 0° AOI.

The blue shaded region indicates the coating design wavelength range, with the following specification:

- $R_{abs} \leq 1.5\%$ @ 750 - 800nm
- $R_{abs} \leq 1.0\%$ @ 800 - 1550nm
- $R_{avg} \leq 0.7\%$ @ 750 - 1550nm

Data outside this range is not guaranteed and is for reference only.

[Click Here to Download Data](#)

Compatible Mounts