

NOTES:

- SUBSTRATE MATERIAL:
NITROCELLULOSE
- COATING (APPLY ACROSS COATING APERTURE)

S1: DIELECTRIC
33% R @ 400 - 700nm @ 45° AOI
67% T @ 400 - 700nm @ 45° AOI
R/T TOLERANCE: ±3%

S2: NONE

- ROHS : EXEMPT

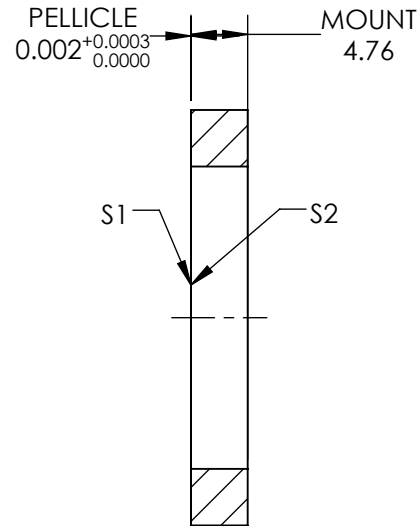
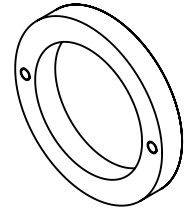

SECTION A-A

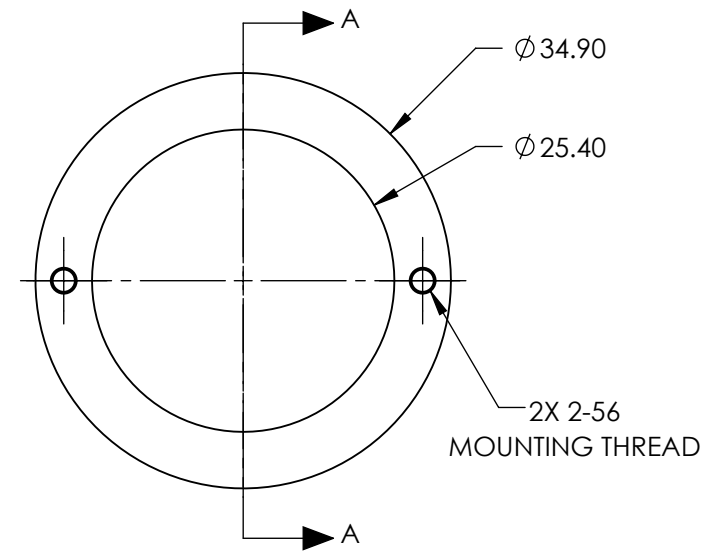

**FOR INFORMATION ONLY:
DO NOT MANUFACTURE
PARTS TO THIS DRAWING**

SPECIFICATIONS SUBJECT TO CHANGE WITHOUT NOTICE
DIMENSIONS ARE FOR REFERENCE ONLY

REV.A.	S1	S2
SHAPE	PLANO	PLANO
SURFACE QUALITY	40-20	40-20
CLEAR APERTURE	Ø25.40	Ø25.40
BEVEL	PROTECTIVE AS NEEDED	PROTECTIVE AS NEEDED



ALL DIMS IN

mm

EO® Edmund Optics®

TITLE

BS PELLICLE 1in DIA 33R/67T

DWG NO

39480

SHEET
1 OF 1